

Technical Data Sheet

Viscosity Correction for F458-1/F460-1 Ex Motor



More than just pumps

Viscosity Correction Curves Using Horsepower and Impellers



33 / 36 Rotor

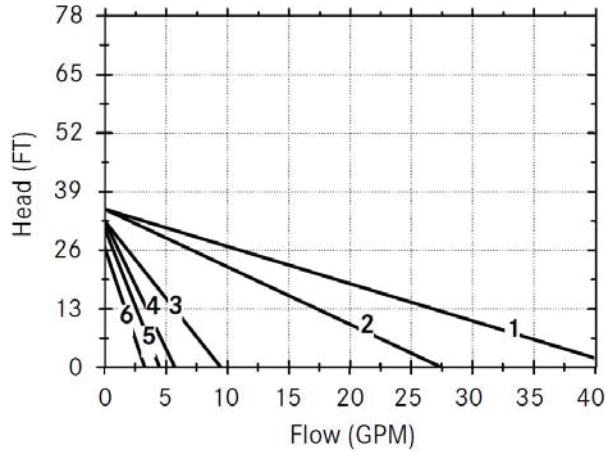

35Z / 33Z Rotor

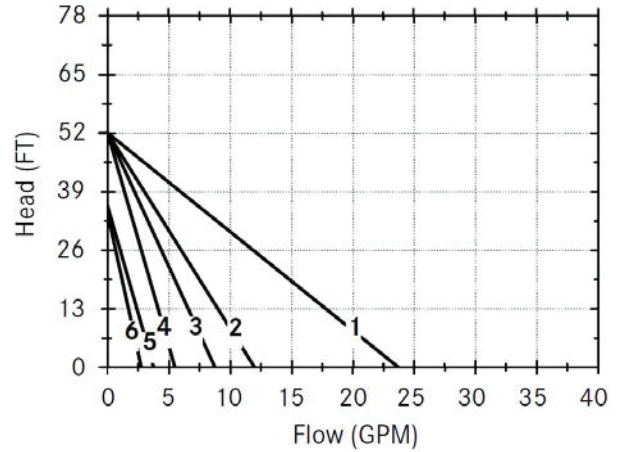

38 Rotor

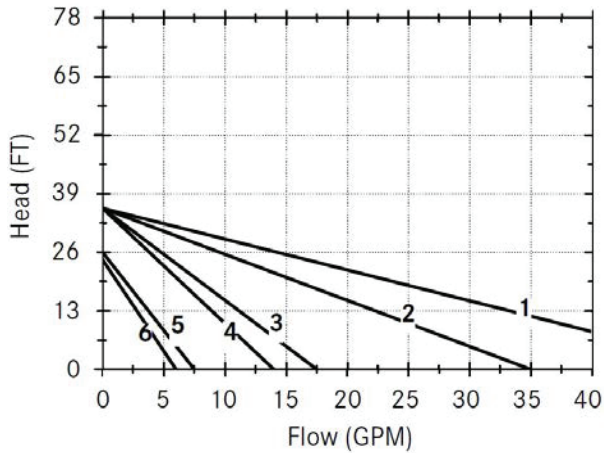

37Z Rotor

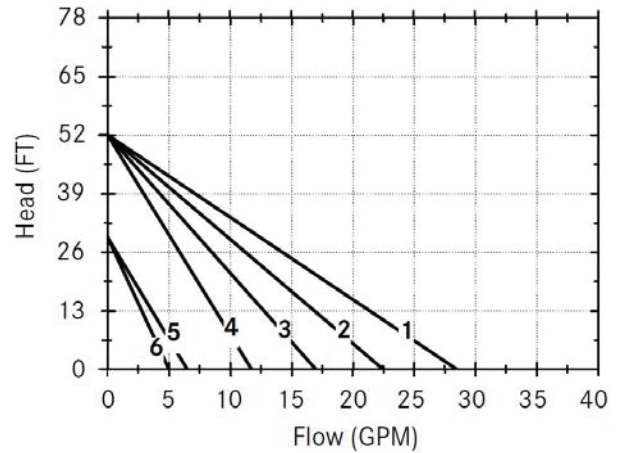

45Z / 43Z Rotor

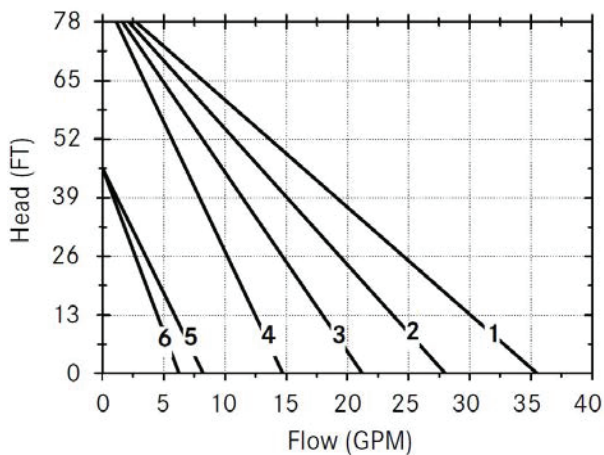

Curve #	Viscosity
1	1 cPs
2	60 cPs
3	250 cPs
4	500 cPs
5	800 cPs
6	1000 cPs

Values ± 10%, S.G. 1, Newtonian fluids.
Please consider overload chart for commutator motors.

FLUX Impeller Types for Low to Medium Viscosity Liquids



Impellers for the requested delivery rate

- ▶ FLUX offers two different types of impellers.
- ▶ The geometry of the axial impeller provides for small flow losses in circumferential direction, flow is almost completely axial. Used when high flow rates are required at low pressure requirements.
- ▶ The geometry of the semi-axial impellers (Z-version) provides mainly for a flow in circumferential direction. Combined with the pressure ring, the flow is redirected in axial direction. This provides a higher delivery pressure at a lower delivery rate. Semi-axial impellers are used in case of an increased pressure requirement.
- ▶ All impellers are in ethylene-tetrafluoroethylene (ETFE).
- ▶ Axial impeller with diameter 38 mm is also available in stainless steel.

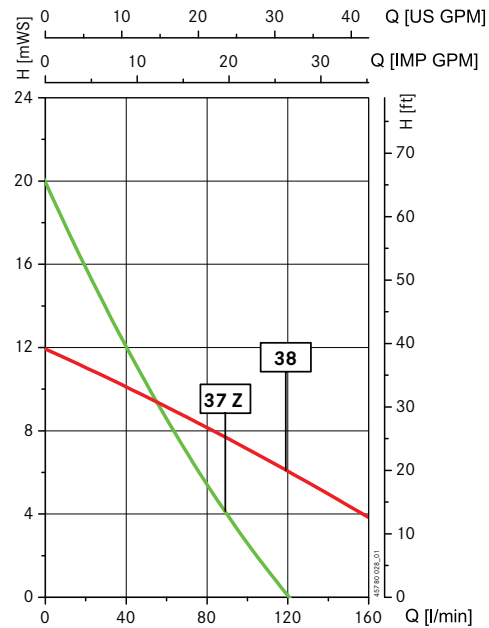

Comparison of the characteristic curve of a drum pump F/FP 430 with motor F 457 with axial impeller 38 mm and semi-axial impeller (Z-version) 37 mm

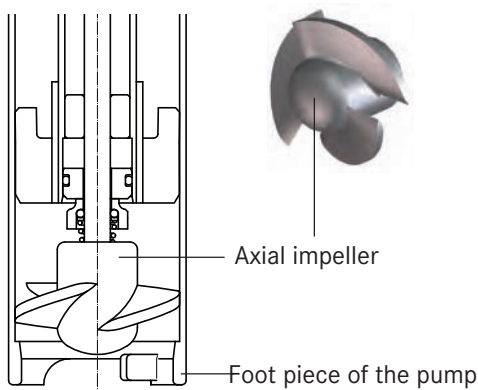

F/FP 430 with mechanical seal and axial impeller

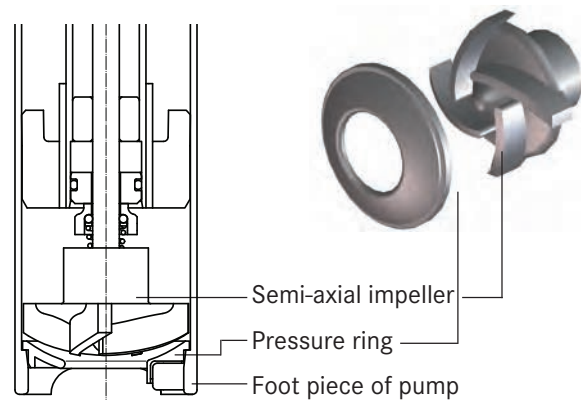

F/FP 430 with mechanical seal and semi-axial impeller (Z-version)

Use of axial impellers

- ▶ For high delivery rates
- ▶ For light media (up to 1.3 S.G.)
- ▶ For short discharge lines
- ▶ For small differences in height
- ▶ For low pressure losses

Use of semi-axial impellers (Z-version)

- ▶ For high delivery heads
- ▶ For heavy media (from 1.3 S.G.)
- ▶ For long discharge lines
- ▶ For big differences in height
- ▶ For pressure losses due to valves and fittings

FLUX PUMPS CORPORATION

300 Townpark Drive, Suite 110 Kennesaw, GA 30144, USA

Phone 800-367-3589

info@fluxpumpsusa.com

www.fluxpumpsusa.com